

REAL TIME. ON-LINE. WIRELESS.

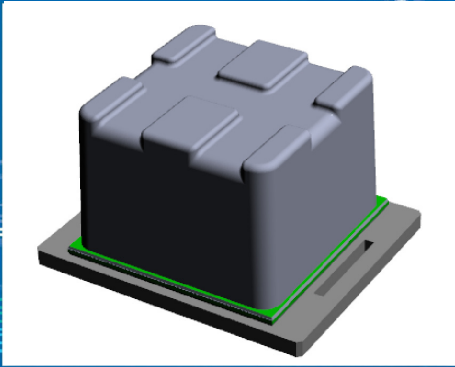

Key Features

- Temperature Range: -20°C - 120°C
- Center Frequency: 429.503 MHz
- Temperature Coefficient of Frequency: 17.35 ppm/K

Typical Applications

- Switchgear where **circuit breaker contact post** mounting on varying diameters is desired (additional tie wrap required)
- Applications where providing power to sensors is difficult

Measurement Conditions

- Ambient Temperature: 25°C
- Wireless Reader Tx Level: -6 dBm
- Wireless Reader Tx Antenna Gain: 0 dBi
- Wireless Reader Rx Threshold ¹: 0 dB

Performance Specifications²

Parameter	Typical Value	Tolerance/Limit
Minimum Signal Strength (Reader Hardware Rx Readout)	19 dB	min. 15 dB
Centre frequency [f _c] (Reader hardware frequency readout)	429.503 ³ MHz	± 75 ³ kHz
Time Domain Slope ⁴	1.3 dB/μs	-
Operating Temperature Range [OTR]	-	-20°C to 120°C
Storage Temperature Range	-	-20°C to 120°C
Temperature Coefficient of Frequency [TC _f] ⁵	17.35 ppm/K	-
Temperature Error due to Aging ⁶ within OTR	0.29 K	max. -2K to 2K

Notes:

1. In reference to internal reader signal level.
2. Under conditions specified in the Measurement Environment (see following pages). Specifications for the sensor have been established by using the SenGenuity WSR-T2 Wireless SAW Reader. See reader specification sheet for information on standard set up of reader hardware.
3. Preliminary values.
4. Decay of time domain response envelope, measured with 4MHz span around center (resonant) frequency.
5. $\Delta f[\text{Hz}] = \text{TC}_f(\text{ppm/K}) \times (T - T_r) \times f_c[\text{MHz}]$
6. For 1000h continuous operation at maximum operating temperature.

Typical Temperature Error (maximum operating temperature)

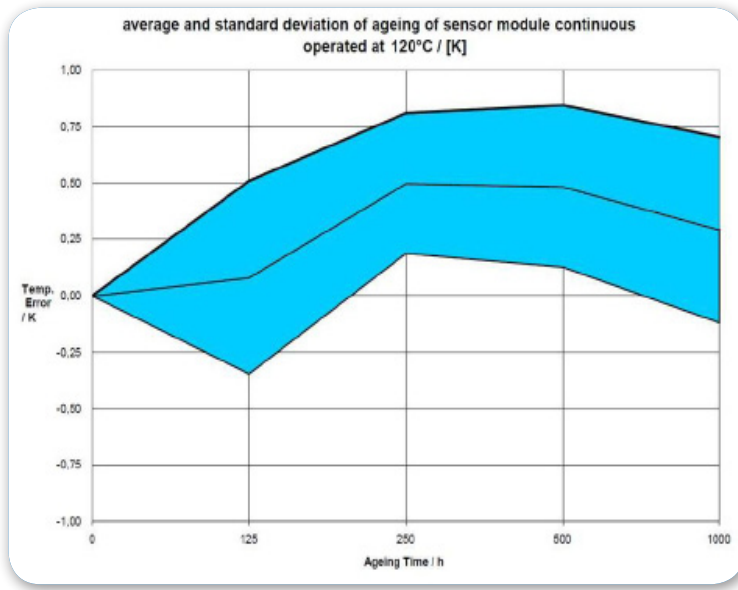

Sensor Characteristics (Temperature Characteristics and Time Domain Response)

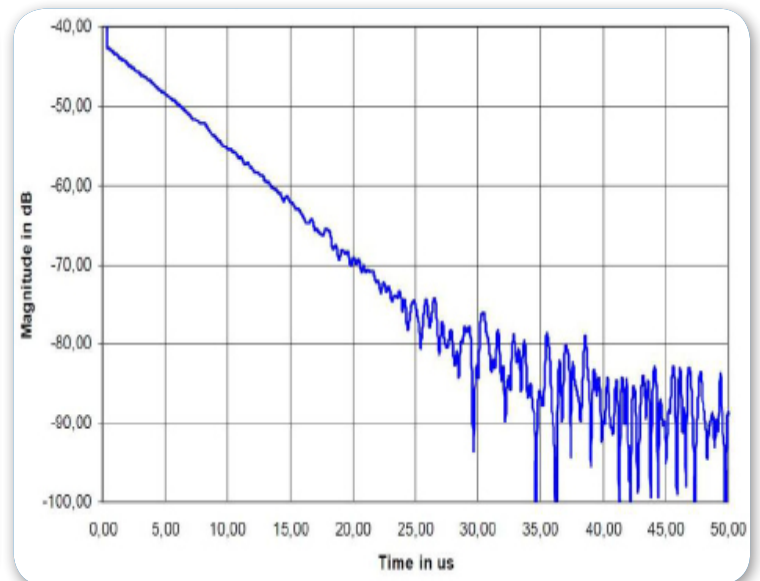
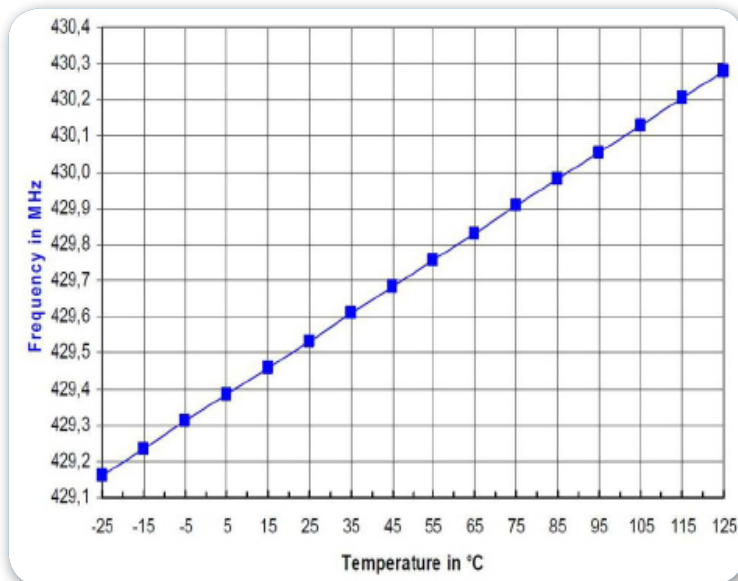

Construction (all dimensions in mm)

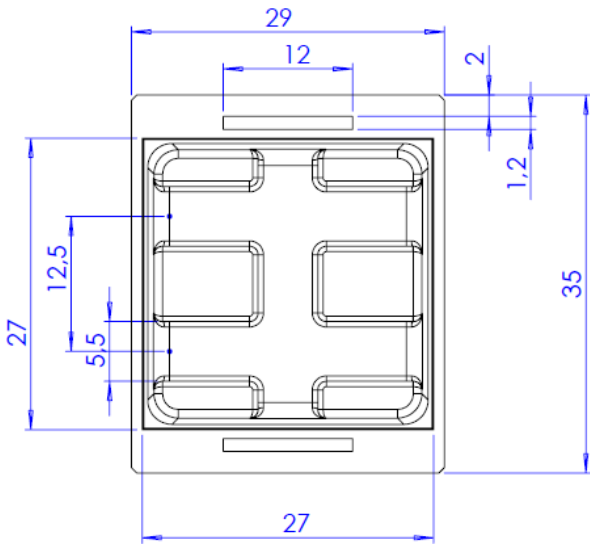
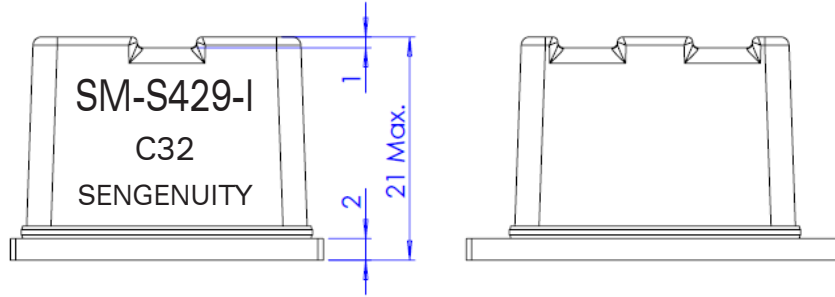

Datecode: Year + Week	
C	2012
D	2013
E	2014

Circuit Diagram

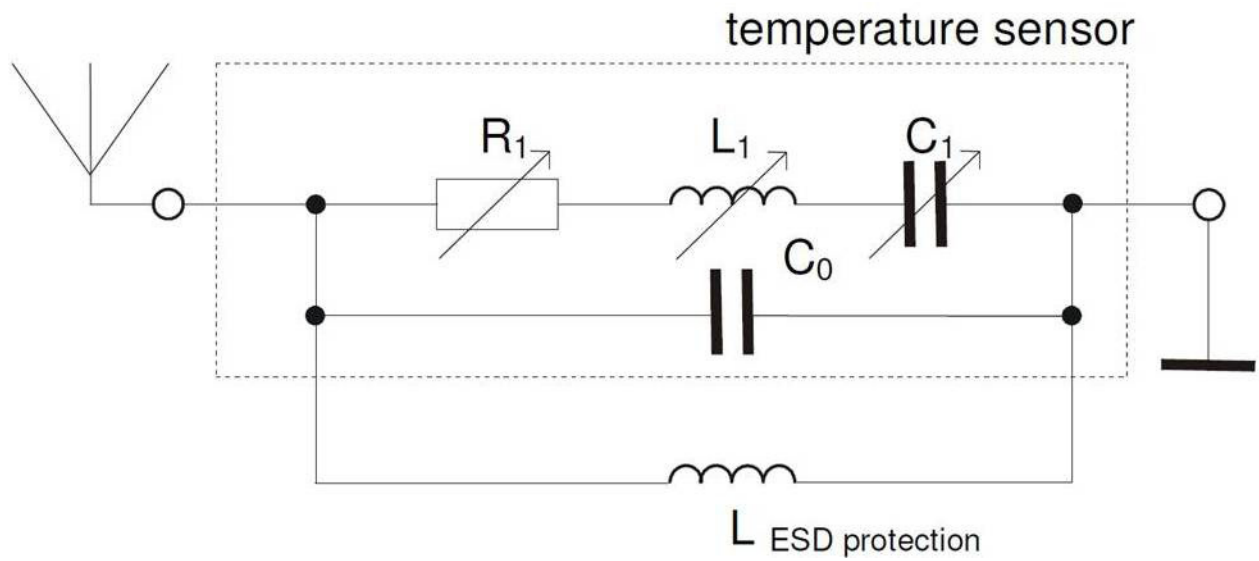

Stability Characteristics and Reliability

After the following tests the sensor shall meet the whole specification:

- Shock: 500g, 1 ms, half sine wave, 3 shocks each plane;
DIN IEC 68 T2 - 27
- Vibration: 10 Hz to 500 Hz, 0,35 mm or 5 g respectively, 1 octave per min, 10 cycles per plan, 3 plans;
DIN IEC 68 T2 - 6
- Change of temperature: -55 °C to 125°C / 30 min. each / 10 cycles;
DIN IEC 68 part 2 – 14 Test N
- ESD: MIL-STD-883E using coupling network of ISO 10605 and EN 6100-4-2;
HBM:250V
- Impact Strength: 1J , rod pendulum, impact at upper edge of sensor module cap
(maximum energy of impact may occur once in sensor module lifetime)

This sensor is RoHS compliant (2002/95/EG, 2005/618/EG)

Measurement Environment

Specified electrical properties shall be measured under the following test conditions

1. Ambient temperature: 25°C
2. Humidity: 30% - 60%
3. Distance sensor antenna to reader antenna: 80cm (signal path shall have minimum free 1st Fresnel zone)
4. Anechoic environment: Reflected RF signals (multipath echos) should be attenuated minimum 25 dB in reference to direct signal between reader / sensor module
5. Inband interferer: Outside signals in the measured frequency range shall be attenuated by 40 dB in reference to reader Tx signal power
6. Sensor mounting: Sensor module has to be mounted on a ground plane perpendicular to sensor module antenna rotation axis
7. Antenna alignment: Rotation axis of sensor module and reader antenna have to be parallel and perpendicular to transmission path

The frequency and signal level is influenced by reactive interaction to materials within the reactive near field, approximately 17.5 cm. For a description of an example implementation of these requirements see application note [Sensor Module Test Setup](#).

History

Version	Changes	Name	Date
A	generation of sensor module specification	T.Martens	6-30-2011
B	correction of error in typical value for minimum signal level	T.Martens	3-22-2012
C	updated drawings to reflect change of brass base	T.Martens	8-09-2012

Product status and specifications are subject to change.

DISCLAIMER

Vectron International reserves the right to make changes to the product(s) and or information contained herein without notice. No liability is assumed as a result of their use or application.
No rights under any patent accompany the sale of any such product(s) or information.

REV. C